

Phoenix ES AC Vector Drive



3 HP to 3500 HP

Standard Features:

- * OPEN LOOP AC VECTOR CONTROL
 - 100 TO 1 SPEED RANGE, 0.1% SPEED REGULATION - OPEN LOOP CONTROL (STANDARD)
- * CLOSED LOOP AC VECTOR CONTROL
 - 1000 TO 1 SPEED RANGE, 0.01% SPEED REGULATION - CLOSED LOOP CONTROL (WITH ENCODER FEEDBACK CARD)
 - SPEED CONTROL, TORQUE CONTROL, SPEED CONTROL WITH TORQUE LIMIT, TORQUE CONTROL WITH SPEED LIMIT
 - FULL TORQUE AT ZERO SPEED – HOLD POSITION / HOLD ZERO SPEED
 - RIGID AND NON-RIGID POSITION CONTROL INCLUDING ORIENTATION
 - PERMANENT MAGNET MOTOR CONTROL
- * NO NEED TO PERFORM AUTO-TUNE ROUTINE OR DISCONNECT THE MOTOR FROM THE LOAD OR DURING DRIVE START-UP
- * OPERATOR KEYPAD WITH ENGLISH LANGUAGE DISPLAY – 2 LINE, 32 CHARACTER. EASILY DISPLAY ANY PARAMETER INCLUDING MOTOR SPEED, MOTOR CURRENT, MOTOR VOLTAGE, KW, AND KWH. USER PROGRAMMABLE PARAMETER SCALING AND FORMATTING – DISPLAY "REAL WORLD" VALUES – GPM, CFM, PSI
- * OPERATOR KEYPAD INCLUDES SPEED INCREASE/DECREASE KEYS, START/STOP, FORWARD/REVERSE, AND FAULT RESET KEYS ALSO LED'S FOR "CURRENT LIMIT", "FWD/REV", "RUN", AND "FAULT."
- * 50°C AMBIENT TEMPERATURE RATING (NEMA 1 ENCLOSED DRIVES)
- * TOLERATES HIGH INPUT AC LINE VOLTAGES – 250/500/600 VAC +10% (240/480/575 VAC INPUT)
- * GROUND FAULT AND LINE TO LINE SHORT CIRCUIT PROTECTION
- * PROGRAMMABLE SPEED SENSITIVE MOTOR OVERLOAD PROTECTION TO COMPLY WITH UL 508C SECTIONS 43.3, 43.4 AND 43.5
- * SPEED INCREASE / DECREASE (MOP) FUNCTION
- * S CURVE ACCEL/DECEL CONTROL



- * USER PROGRAMMABLE AUTO-RESTART FUNCTION
- * BI-DIRECTIONAL FLYCATCHER (START INTO A ROTATING MOTOR) – NO INERTIA LIMITS
- * BUILT IN KW / KWH METERING AND TOTAL COST OF POWER CALCULATOR
- * PROGRAMMABLE TIME BASED FUNCTION GENERATOR AND PROGRAMMABLE THRESHOLD DETECTORS
- * PROGRAMMABLE TIME DELAY AND LOGIC FUNCTIONS (AND, OR, NOR) OF BIT PARAMETERS, DIGITAL INPUTS AND OUTPUTS
- * ADDING, SUBTRACTING, MULTIPLYING, DIVIDING, RAMPING, LIMITING, AND/OR FILTERING FUNCTIONS OF PARAMETERS AND ANALOG INPUTS AND OUTPUTS
- * RUN TIME AND POWER ON TIME COUNTDOWN TIMERS WITH ALARMS PLUS RUN TIME AND POWER ON TIME TOTALIZERS
- * CRITICAL SPEED REJECTION, 3 BANDS – INDIVIDUALLY PROGRAMMABLE BANDWIDTH
- * AUTO LOGGING FAULT HISTORY - LAST 10 FAULTS SAVED IN ORDER OF OCCURRENCE
- * 8 DIGITAL INPUTS, 24 VDC (7 PROGRAMMABLE INPUTS AND 1 FIXED STOP/ENABLE INPUT)
- * 2 PROGRAMMABLE DIGITAL OUTPUTS – TWO FORM C DRY CONTACTS RATED 5 AMPS AT 115VAC
- * 2 PROGRAMMABLE ANALOG INPUT SIGNALS, -10 VDC TO +10 VDC OR 4 TO 20 MA
- * 2 PROGRAMMABLE ANALOG OUTPUT SIGNALS, -10 VDC TO +10 VDC
- * DC BRAKING
- * FIXED OR VARIABLE CARRIER FREQUENCY
- * MUCH, MUCH, MORE..

THREE YEAR WARRANTY

MADE IN USA

The Phoenix series of AC Drives was designed with one goal in mind: To create the most reliable and rugged Digital AC Drive on the market today. Reading through our standard features, it's easy to see the engineering detail that has made the Phoenix an outstanding product. To prove our commitment, we back each drive with a Three Year Warranty.

OUTSTANDING FEATURES

Open or Closed Loop Vector Control Phoenix ES is a High Performance AC Vector Drive. Without modification, it is an Open Loop Vector Drive. With the addition of Encoder Feedback, it becomes a Closed Loop Vector Drive. Vector Control offers improved low speed operation and a wider operating speed range. It also offers better Speed Regulation and true control of AC Motor Torque. When operating in the Closed Loop Mode, the Phoenix EX will hold Zero Speed and Hold Position.

High Voltage Ratings Line voltages in the United States are now averaging as high as 500VAC, in Canada that figure is 600VAC. Designing a product that doesn't take this fact into consideration will result in a product that will have power bridge failures or at best, nuisance overvoltage tripping. The Phoenix is rated to handle these new voltage averages with $\pm 10\%$ to spare!

Built In Radio Frequency Filter The RFI filter, that is standard in the Phoenix, reduces noise in the radio frequency band which may be generated by the drive. The R.F.I. filter has a secondary benefit of protecting the drive from high voltage transients which occur when attached to motors with long leads. Many drive manufacturers ignore these potential problems that can cause radio communications problems in a facility and weaken the integrity of the drive.

Input Line Suppression Metal oxide varistors are included on each unit to absorb line voltage transients, not only phase to phase, but also phase to ground. Without these suppression devices the drive's power semiconductors are exposed to high potential voltages.

Short Circuit Protection If any of the output phases are shorted together (motor stator failure) or if an output phase shorts to ground, the Phoenix will safely shut down protecting itself until the short is cleared. These types of conditions often occur during installation when a power lead is nicked and shorts to conduit.

50°C Ambient Temperature We know there are many places in North America where the ambient temperature can be very high during the summer months. Many products coming from overseas, however, have lowered their cost by providing a product that can only handle an ambient temperature of 104°F(40°C) in an enclosure. The Phoenix has been designed to handle the heat with a rating of 122°F(50°C) in a Nema type 1 enclosure.

Additional Standard Features:

- * **Backlit Keypad with Configurable Display**
- * **Motor Overload Protection - Meets NEC 430**
- * **Coast to Rest or Ramp Stop**
- * **Isolated Control Circuitry**
- * **Non-Volatile Parameter Storage**
- * **User Security Code**
- * **Programmable Auto Restart**
- * **S Curve Accel / Decel**
- * **Eight Preset Speeds**
- * **Eight Accel / Decel Rates**
- * **Two Timers with Alarms for Customer Use**
- * **Two Threshold Detectors for Customer Use**
- * **Setpoint Control with PID**
- * **DC Injection Braking**
- * **Critical Speed Rejection**
- * **Kw / Kwh Metering**

ENGINEERING DATA

Electrical Specifications:

Rated Input Voltage:	200-250Vac, 380-500Vac, 500-600Vac -15% of minimum, +10% of maximum.
Frequency Tolerance:	45-65 Hz
Number of Phases:	3
Displacement Power Factor:	.95 or greater
Efficiency:	97% or greater at rated current
Max. Short Circuit Current Rating:	200,000A rms symmetrical, 600 volts (when used with AC input line fuses specified in tables 1-1 to 1-3 of the Instruction Manual).

Control Specifications:

Control Method:	Sine coded PWM with programmable carrier. Space Vector control.
Output Voltage:	0 to rated voltage.
Output Frequency Range:	0 to 600 Hz.
Frequency accuracy:	Analog reference: 0.1% of max frequency. Digital reference: 0.01% of max frequency.
Frequency resolution:	Analog reference: 0.06Hz at 60Hz. Digital reference: 0.001Hz at 60Hz.
Accel/Decel:	0.1 to 3276 sec.
Drive overload:	At Constant Torque: 150% of drive rated output for 1 minute. At Variable Torque: 120% of drive rated output for 1 minute.
Inverse Time Overload:	Programmable motor overload protection to comply with N.E.C. Article 430.
Current limit:	Proactive current limit programmable in % of motor rated current.
Braking torque:	Approximately 20%.
Maximum connected motor:	2 times rated drive horsepower.

Environmental Specifications:

Ambient Temperature:	-10°C to 50°C (14°F to 122°F) Nema type 1 enclosed.
Storage Temperature:	-40°C to 70°C (-40°F to 158°F) Nema type 1 enclosed.
Altitude:	Sea level to 3300 Feet [1000m] without derating.
Humidity:	95% relative humidity non-condensing.
Vibration:	9.8m/sec ² (1.0G) peak.
Immunity:	IEEE C62.41-1991 Category B (Formerly known as IEEE 587) EN50082-2 (Generic Immunity Standard).
Input R.F.I. Filter:	Standard on all models.

Physical attributes:

Mounting:	Though hole or panel mount for size 0 to size 3 drives. Size 4 drives are free standing enclosure.
Nema Rating:	Type 1 (IP20) as standard, Type 12 (IP54) optional.
Construction:	Steel construction (reduces E.M.I.)

Protective Features:

- Programmable motor overload protection to comply with UL 508C sections 43.3, 43.4 and 43.5.
- Drive overload protection to protect inverter.
- Motor stall protection at acceleration /deceleration and constant speed operation.
- Peak output current monitoring to protect against line-to-line shorts and line-to-ground shorts.
- Heatsink over-temperature monitoring.
- AC line overvoltage protection.

- DC bus over-voltage protection.
- DC bus under-voltage protection.
- Programmable stall protection.
- Internal power supply monitoring.
- AC power loss detection.
- Critical speed rejection with programmable 3 points with bandwidth to avoid mechanical resonance.
- Flycatcher "catch a spinning motor".
- Password protection to prevent parameter changes by unauthorized personnel.
- 4 to 20ma reference loss detection.
- Programmable thresholds and more.

Control I/O:

- 8 Digital Inputs: 7 user programmable inputs and 1 dedicated input for "Stop", rated for 24Vdc logic control.
- 2 Digital Outputs: 2 programmable dry contacts rated 115Vac @ 5A; 30Vdc @ 3.5A.
- 2 Analog Inputs: -10 to +10V (10 bits) with input impedance: 75K Ω , or 4-20 mA @ 500 Ω - Programmable.
- 2 Analog Outputs: -10 to +10V (10 bits) @ 2 mA max; output impedance = 100 Ω . - Programmable.
- 1 Voltage Reference: +15Vdc reference @ 10 mA max.
- 24Vdc source: Use to power operator pushbuttons and US Drives option boards: 24Vdc @ 80 mA max.

Standard Drives Features:

- New generation IGBT.
- Nema type 1 (IP20) as standard for all models.
- 50°C ambient with standard Nema type 1 (IP20) enclosure.
- High voltage ratings: 250Vac+10% , 500Vac+10% models, and 600Vac+10% models
- Modbus RTU serial communications ready.
- Input line suppression: Metal oxide varistors for line-to-line and line-to-ground voltage surge protection.
- Built-in radio frequency filter.
- Nonvolatile parameter storage.
- All parameters are saved in EEPROM (nonvolatile).
- Auto logging fault history: ten last faults recorded in order of occurrence.
- Simple programming through the Real-time Operator module (R.O.M.) with all data entries and monitoring in engineering units with English descriptions.
- Injection DC Braking with braking time calculated automatically by the drive.
- Critical speed rejection.
- Programmable auto restart.
- Parameter security code.
- User definable displays with programmable format and parameter scaling.
- 7 programmable digital inputs for custom setups.
- Metering: AC line voltage, motor current, motor voltage, DC Bus voltage, Kw, Kwh, running Kwh cost, and more...
- 8 programmable digital preset speeds with user selectable acceleration and deceleration rates.
- M.O.P. function.
- Programmable PWM carrier frequency, fixed or variable.
- Programmable Time Based Function Generator and Programmable Threshold Detectors
- Run Time and Power on Time Countdown Timers with Alarms plus Run Time and Power on Time Totalizers
- Bi-directional auto-speed search (flycatcher) for starting into rotating loads.
- S-curve accel/decel control.
- Programmable time delay and logic functions (AND, OR, NOR) of bit parameters, digital inputs and outputs.
- Adding, subtracting, multiplying, dividing, ramping, limiting, and/or filtering functions of parameters and analog inputs and outputs.
- Parameters can be displayed, routed to an analog/digital output, or re-routed and used as an input parameter to control another function within the drive.
- User programmable functions and modes.
- Open Loop or closed-loop control operation easy setup.
- Precise control of motor speed and torque.
- Rigid and non-rigid position control including orientation.
- Induction and permanent magnet motor control.

CATALOG NUMBER EXPLANATION

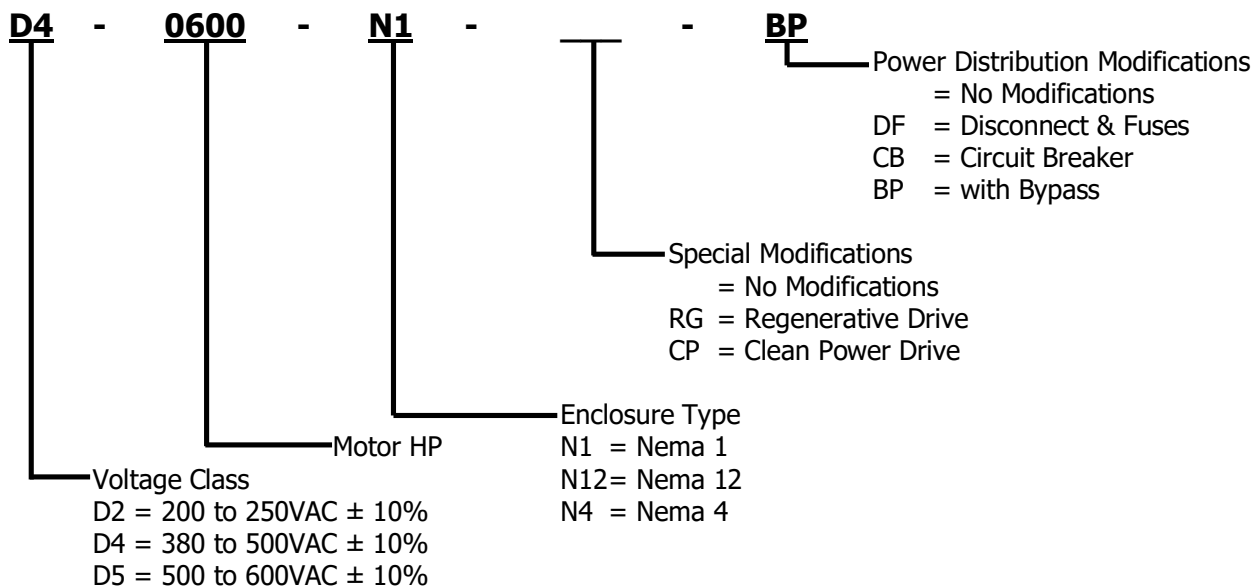

CATALOG NUMBER SELECTION / RATING TABLES

200-250VAC (-10% to +10%)												
Frame Designation	NEMA 1 (IP20) Catalog Number	Motor HP ¹		Output Current (Amps)		Output KVA ⁴		Input Current (Amps)		Input KVA ⁴		Maximum Recommended AC Line Fuses ⁵ (Amps)
		High Overload Capacity HT ²	Normal Overload Capacity NT ³	High Overload Capacity HT ²	Normal Overload Capacity NT ³	High Overload Capacity HT ²	Normal Overload Capacity NT ³	High Overload Capacity HT ²	Normal Overload Capacity NT ³	High Overload Capacity HT ²	Normal Overload Capacity NT ³	
SIZE 0	D2-0005-N1	3	5	10	16	4	7	12	19	5	8	35
	D2-0007-N1	5	7.5	16	22	7	9	19	25	8	10	40
	D2-0010-N1	7.5	10	22	28	9	12	25	33	10	14	50
	D2-0015-N1	10	15	28	42	12	17	25	36	10	15	60
	D2-0020-N1	15	20	42	54	17	22	36	50	15	21	70
	D2-0020CT-N1	20	-	54	-	22	-	50	-	21	-	70
SIZE 1	D2-0025-N1	20	25	54	68	22	28	50	61	21	25	90
	D2-0030-N1	25	30	68	85	28	35	61	79	25	33	100
	D2-0030CT-N1	30	-	80	-	33	-	74	-	31	-	100
SIZE 2	D2-0040-N1	30	40	80	104	33	43	74	96	31	40	150
	D2-0050-N1	40	50	104	130	43	54	96	120	40	50	200
	D2-0060-N1	50	60	130	163	54	68	120	155	50	64	250
	D2-0075-N1	60	75	154	192	60	80	140	186	58	77	300
	D2-0100-N1	75	100	192	248	80	103	186	230	77	96	300
	D2-0100CT-N1	100	-	248	-	103	-	230	-	96	-	300
SIZE 3	D2-0125VT-N1	-	125	-	312	-	130	-	290	-	121	⁶
	D2-0125CT-N1	125	-	312	-	130	-	290	-	121	-	⁶
	D2-0150VT-N1	-	150	-	360	-	150	-	335	-	139	⁶
	D2-0150CT-N1	150	-	360	-	150	-	335	-	139	-	⁶
	D2-0200VT-N1	-	200	-	480	-	200	-	446	-	186	⁶
	D2-0200CT-N1	200	-	480	-	200	-	446	-	186	-	⁶
	D2-250VT-N1	-	250	-	602	-	250	-	560	-	233	⁶
	D2-0250CT-N1	250	-	602	-	250	-	560	-	233	-	⁶

¹ Horsepower rating based on 230 VAC Motors.

² High Overload Capacity Drives (HT) produce 150% of Rated Drive Output Current for 1 minute.

³ Normal Overload Capacity Drive (NT) produce 120% of Rated Drive Output Current for 1 minute.

⁴ Output and Input KVA at nominal 240 VAC.

⁵ UL Class T, J, and Semiconductor Fuses (preferred): Ferraz Shawmut A50Q, Bussmann FWH.

⁶ Included as standard.

CATALOG NUMBER SELECTION / RATING TABLES

380-500VAC (-10% to +10%)												
Frame Designation	NEMA 1 (IP20) Catalog Number	Motor HP ¹		Output Current (Amps)		Output KVA ⁴		Input Current (Amps)		Input KVA ⁴		Maximum Recommended AC Line Fuses ⁵ (Amps)
		High Overload Capacity HT ²	Normal Overload Capacity NT ³	High Overload Capacity HT ²	Normal Overload Capacity NT ³	High Overload Capacity HT ²	Normal Overload Capacity NT ³	High Overload Capacity HT ²	Normal Overload Capacity NT ³	High Overload Capacity HT ²	Normal Overload Capacity NT ³	
SIZE 0	D4-0007-N1	5	7.5	8	11	7	9	10	13	8	11	25
	D4-0010-N1	7.5	10	11	14	9	12	13	17	11	14	30
	D4-0015-N1	10	15	14	21	12	17	17	25	14	21	40
	D4-0020-N1	15	20	21	27	17	22	25	33	21	27	50
	D4-0025-N1	20	25	27	34	22	28	26	31	22	26	50
	D4-0030-N1	25	30	34	43	28	36	31	38	26	32	60
	D4-0040-N1	30	40	40	52	33	43	36	48	30	40	70
D4-0040CT-N1	40	-	52	-	43	-	48	-	40	-	-	70
SIZE 1	D4-0050-N1	40	50	52	66	43	55	48	56	40	47	90
	D4-0060-N1	50	60	65	82	54	68	56	72	47	60	100
	D4-0060CT-N1	60	-	77	-	64	-	67	-	56	-	100
SIZE 2	D4-0075-N1	60	75	77	97	64	81	67	83	56	69	125
	D4-0100-N1	75	100	96	124	80	103	86	110	71	91	175
	D4-0125-N1	100	125	124	156	103	130	110	139	91	116	200
	D4-0150-N1	125	150	156	180	130	150	139	163	116	136	250
	D4-0200-N1	150	200	180	240	150	200	167	223	139	186	350
D4-0200CT-N1	200	-	240	-	200	-	223	-	186	-	-	350
SIZE 3	D4-250VT-N1	-	250	-	302	-	251	-	281	-	234	6
	D4-0250CT-N1	250	-	302	-	251	-	281	-	234	-	6
	D4-0300VT-N1	-	300	-	361	-	300	-	336	-	279	6
	D4-0300CT-N1	300	-	361	-	300	-	336	-	279	-	6
	D4-0350VT-N1	-	350	-	414	-	344	-	385	-	320	6
	D4-0350CT-N1	350	-	414	-	344	-	385	-	320	-	6
	D4-0400VT-N1	-	400	-	477	-	397	-	444	-	369	6
	D4-0400CT-N1	400	-	477	-	397	-	444	-	369	-	6
	D4-0450VT-N1	-	450	-	540	-	449	-	503	-	418	6
	D4-0450CT-N1	450	-	540	-	449	-	503	-	418	-	6
	D4-0500VT-N1	-	500	-	600	-	499	-	558	-	464	6
	D4-0500CT-N1	500	-	600	-	499	-	558	-	464	-	6
	SIZE 4	D4-0600VT-N1	-	600	-	720	-	599	-	670	-	557
D4-0600CT-N1		600	-	720	-	599	-	670	-	557	-	6
D4-0700VT-N1		-	700	-	840	-	698	-	781	-	649	6
D4-0700CT-N1		700	-	840	-	698	-	781	-	649	-	6
D4-0800VT-N1		-	800	-	960	-	798	-	893	-	742	6
D4-0800CT-N1		800	-	960	-	798	-	893	-	742	-	6
D4-0900VT-N1		-	900	-	1080	-	898	-	1004	-	835	6
D4-0900CT-N1		900	-	1080	-	898	-	1004	-	835	-	6
D4-1000VT-N1		-	1000	-	1200	-	998	-	1116	-	928	6
D4-1000CT-N1		1000	-	1200	-	998	-	1116	-	928	-	6
D4-1250VT-N1		-	1250	-	1500	-	1247	-	1395	-	1160	6
D4-1250CT-N1		1250	-	1500	-	1247	-	1395	-	1160	-	6
D4-1500VT-N1		-	1500	-	1800	-	1496	-	1674	-	1392	6
D4-1500CT-N1		1500	-	1800	-	1496	-	1674	-	1392	-	6
D4-1750VT-N1		-	1750	-	2100	-	1746	-	1953	-	1624	6
D4-1750CT-N1		1750	-	2100	-	1746	-	1953	-	1624	-	6
D4-2000VT-N1		-	2000	-	2400	-	1995	-	2232	-	1856	6
D4-2000CT-N1	2000	-	2400	-	1995	-	2232	-	1856	-	6	
D4-2500VT-N1	-	2500	-	3000	-	2494	-	2790	-	2320	6	
D4-2500CT-N1	2500	-	3000	-	2494	-	2790	-	2320	-	6	

THIS VOLTAGE SERIES HAS A MAXIMUM HP RATING OF 3,000HP

¹ Horsepower rating based on 460 VAC Motors.

² High Overload Capacity Drives (HT) produce 150% of Rated Drive Output Current for 1 minute.

³ Normal Overload Capacity Drive (NT) produce 120% of Rated Drive Output Current for 1 minute.

⁴ Output and Input KVA at nominal 240 VAC.

⁵ UL Class T, J, and Semiconductor Fuses (preferred): Ferraz Shawmut A50Q, Bussmann FWH.

⁶ Included as standard.

CATALOG NUMBER SELECTION / RATING TABLES

500-600VAC (-10% to +10%)												
Frame Designation	NEMA 1 (IP20) Catalog Number	Motor HP ¹		Output Current (Amps)		Output KVA ⁴		Input Current (Amps)		Input KVA ⁴		Maximum Recommended AC Line Fuses ⁵ (Amps)
		High Overload Capacity HT ²	Normal Overload Capacity NT ³	High Overload Capacity HT ²	Normal Overload Capacity NT ³	High Overload Capacity HT ²	Normal Overload Capacity NT ³	High Overload Capacity HT ²	Normal Overload Capacity NT ³	High Overload Capacity HT ²	Normal Overload Capacity NT ³	
SIZE 0	D5-0007-N1	5	7.5	7	9	7	9	9	11	9	11	20
	D5-0010-N1	7.5	10	9	12	9	12	11	13	11	13	25
	D5-0015-N1	10	15	11	17	11	17	13	20	13	20	35
	D5-0020-N1	15	20	17	22	17	22	20	25	20	25	40
	D5-0025-N1	20	25	22	28	22	28	22	28	22	28	40
	D5-0030-N1	25	30	27	34	27	34	27	34	27	34	50
	D5-0040-N1	30	40	32	41	32	41	32	40	32	40	60
D5-0040CT-N1	40	-	41	-	41	-	40	-	40	-	-	60
SIZE 1	D5-0050-N1	40	50	41	52	41	52	40	48	40	48	80
	D5-0060-N1	50	60	52	65	52	65	54	61	54	61	90
	D5-0075-N1	60	75	62	78	62	78	58	72	58	72	100
	D5-0075CT-N1	75	-	77	-	77	-	75	-	75	-	150
SIZE 2	D5-0100-N1	75	100	77	99	77	99	75	96	75	96	150
	D5-0125-N1	100	125	99	125	99	124	96	124	96	123	175
	D5-0150-N1	125	150	125	157	124	156	124	154	123	153	200
	D5-0200-N1	150	200	144	192	143	191	142	191	141	190	300
	D5-0200CT-N1	200	-	192	-	191	-	191	-	190	-	300
SIZE 3	D5-250VT-N1	-	250	-	242	-	241	-	240	-	239	6
	D5-0250CT-N1	250	-	242	-	241	-	240	-	239	-	6
	D5-0300VT-N1	-	300	-	289	-	288	-	286	-	285	6
	D5-0300CT-N1	300	-	289	-	288	-	286	-	285	-	6
	D5-0350VT-N1	-	350	-	336	-	335	-	333	-	331	6
	D5-0350CT-N1	350	-	336	-	335	-	333	-	331	-	6
	D5-0400VT-N1	-	400	-	382	-	380	-	378	-	377	6
	D5-0400CT-N1	400	-	382	-	380	-	378	-	377	-	6
	D5-0450VT-N1	-	450	-	432	-	430	-	428	-	426	6
	D5-0450CT-N1	450	-	432	-	430	-	428	-	426	-	6
	D5-0500VT-N1	-	500	-	472	-	470	-	467	-	465	6
	D5-0500CT-N1	500	-	472	-	470	-	467	-	465	-	6
	D5-0600VT-N1	-	600	-	576	-	574	-	570	-	568	6
	D5-0600CT-N1	600	-	576	-	574	-	570	-	568	-	6
	SIZE 4	D5-0700VT-N1	-	700	-	672	-	669	-	665	-	663
D5-0700CT-N1		700	-	672	-	669	-	665	-	663	-	6
D5-0800VT-N1		-	800	-	768	-	765	-	760	-	757	6
D5-0800CT-N1		800	-	768	-	765	-	760	-	757	-	6
D5-0900VT-N1		-	900	-	864	-	860	-	855	-	852	6
D5-0900CT-N1		900	-	864	-	860	-	855	-	852	-	6
D5-1000VT-N1		-	1000	-	960	-	956	-	950	-	947	6
D5-1000CT-N1		1000	-	960	-	956	-	950	-	947	-	6
D5-1250VT-N1		-	1250	-	1200	-	1195	-	1188	-	1183	6
D5-1250CT-N1		1250	-	1200	-	1195	-	1188	-	1183	-	6
D5-1500VT-N1		-	1500	-	1440	-	1434	-	1426	-	1420	6
D5-1500CT-N1		1500	-	1440	-	1434	-	1426	-	1420	-	6
D5-1750VT-N1		-	1750	-	1680	-	1673	-	1663	-	1656	6
D5-1750CT-N1		1750	-	1680	-	1673	-	1663	-	1656	-	6
D5-2000VT-N1		-	2000	-	1920	-	1912	-	1901	-	1893	6
D5-2000CT-N1	2000	-	1920	-	1912	-	1901	-	1893	-	6	
D5-2500VT-N1	-	2500	-	2400	-	2390	-	2376	-	2366	6	
D5-2500CT-N1	2500	-	2400	-	2390	-	2376	-	2366	-	6	

THIS VOLTAGE SERIES HAS A MAXIMUM HP RATING OF 3,500HP

¹ Horsepower rating based on 575 VAC Motors.

² High Overload Capacity Drives (HT) produce 150% of Rated Drive Output Current for 1 minute.

³ Normal Overload Capacity Drive (NT) produce 120% of Rated Drive Output Current for 1 minute.

⁴ Output and Input KVA at nominal 240 VAC.

⁵ UL Class T, CC, J, and Semiconductor Fuses (preferred): Ferraz Shawmut A70Q, Bussmann FWP.

⁶ Included as standard.

Dimensions - Nema 1 Enclosed VFD Only

Input Voltage	Motor HP		Approximate Dimensions (HxWxD)	Figure	Mounting	Approximate Weight
	High Overload Capacity (HT)	Normal Overload Capacity (NT)				
200 - 250 VAC (208/230/240)	3 - 7.5	5 - 10	13.05" x 9.0" x 10.9"	1	Wall	30 Lbs.
	10 - 20	15 - 20	13.05" x 9.0" x 10.9"	1	Wall	30 Lbs.
	25 - 30	25 - 30	25" x 11.6" x 11.1"	2	Wall	75 Lbs.
	40 - 100	40 - 100	32.5" x 20.1" x 13.5"	3	Wall	180 Lbs.
	125 - 250	125 - 250	44.2" x 31.1" x 16.8"	4	Wall	500 Lbs.
	Above 250	Above 250	Consult Factory	-	-	-
380 - 500 VAC (380/400/415/480)	5 - 15	7.5 - 20	13.05" x 9.0" x 10.9"	1	Wall	30 Lbs.
	20 - 40	25 - 40	13.05" x 9.0" x 10.9"	1	Wall	30 Lbs.
	50 - 60	50 - 60	25" x 11.6" x 11.1"	2	Wall	75 Lbs.
	75 - 200	75 - 200	32.5" x 20.1" x 13.5"	3	Wall	180 Lbs.
	250 - 500	250 - 500	44.2" x 31.1" x 16.8"	4	Wall	500 Lbs.
	600 - 1000	600 - 1000	72" x 72" x 23.5"	6	Floor	1800 Lbs.
Above 1000	Above 1000	Consult Factory	-	-	-	
525 - 600 VAC (525/575/600)	5 - 15	7.5 - 20	13.05" x 9.0" x 10.9"	1	Wall	30 Lbs.
	20 - 40	25 - 40	13.05" x 9.0" x 10.9"	1	Wall	30 Lbs.
	50 - 75	50 - 75	25" x 11.6" x 11.1"	2	Wall	75 Lbs.
	100 - 200	100 - 200	32.5" x 20.1" x 13.5"	3	Wall	180 Lbs.
	250 - 600	250 - 600	44.2" x 31.1" x 16.8"	4	Wall	500 Lbs.
	700 - 1200	700 - 1200	72" x 72" x 23.5"	6	Floor	1800 Lbs.
Above 1200	Above 1200	Consult Factory	-	-	-	

Dimensions - Nema 12 Enclosed VFD Only

Input Voltage	Motor HP		Approximate Dimensions (HxWxD)	Figure	Mounting	Approximate Weight
	High Overload Capacity (HT)	Normal Overload Capacity (NT)				
200 - 250 VAC (208/230/240)	3 - 7.5	5 - 10	13.05" x 9.0" x 10.9"	1	Wall	35 Lbs.
	10 - 20	15 - 20	13.05" x 9.0" x 10.9"	1	Wall	35 Lbs.
	25 - 30	25 - 30	25" x 11.6" x 11.1"	2	Wall	80 Lbs.
	40 - 100	40 - 100	32.5" x 20.1" x 13.5"	3	Wall	185 Lbs.
	125 - 250	125 - 250	72" x 36" x 23.5"	5	Floor	870 Lbs.
	Above 250	Above 250	Consult Factory	-	-	-
380 - 500 VAC (380/400/415/480)	5 - 15	7.5 - 20	13.05" x 9.0" x 10.9"	1	Wall	35 Lbs.
	20 - 40	25 - 40	13.05" x 9.0" x 10.9"	1	Wall	35 Lbs.
	50 - 60	50 - 60	25" x 11.6" x 11.1"	2	Wall	80 Lbs.
	75 - 200	75 - 200	32.5" x 20.1" x 13.5"	3	Wall	185 Lbs.
	250 - 500	250 - 500	72" x 36" x 23.5"	5	Floor	870 Lbs.
	600 - 1000	600 - 1000	72" x 72" x 23.5"	6	Floor	1800 Lbs.
Above 1000	Above 1000	Consult Factory	-	-	-	
525 - 600 VAC (525/575/600)	5 - 15	7.5 - 20	13.05" x 9.0" x 10.9"	1	Wall	35 Lbs.
	20 - 40	25 - 40	13.05" x 9.0" x 10.9"	1	Wall	35 Lbs.
	50 - 75	50 - 75	25" x 11.6" x 11.1"	2	Wall	80 Lbs.
	100 - 200	100 - 200	32.5" x 20.1" x 13.5"	3	Wall	185 Lbs.
	250 - 600	250 - 600	72" x 36" x 23.5"	5	Floor	870 Lbs.
	700 - 1200	700 - 1200	72" x 72" x 23.5"	6	Floor	1800 Lbs.
Above 1200	Above 1200	Consult Factory	-	-	-	

PHOENIX ES

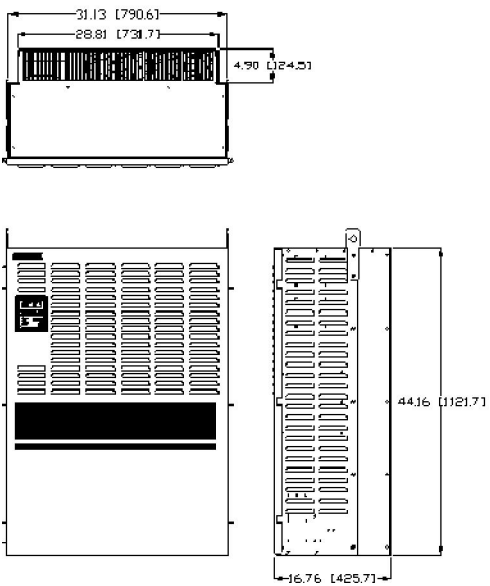
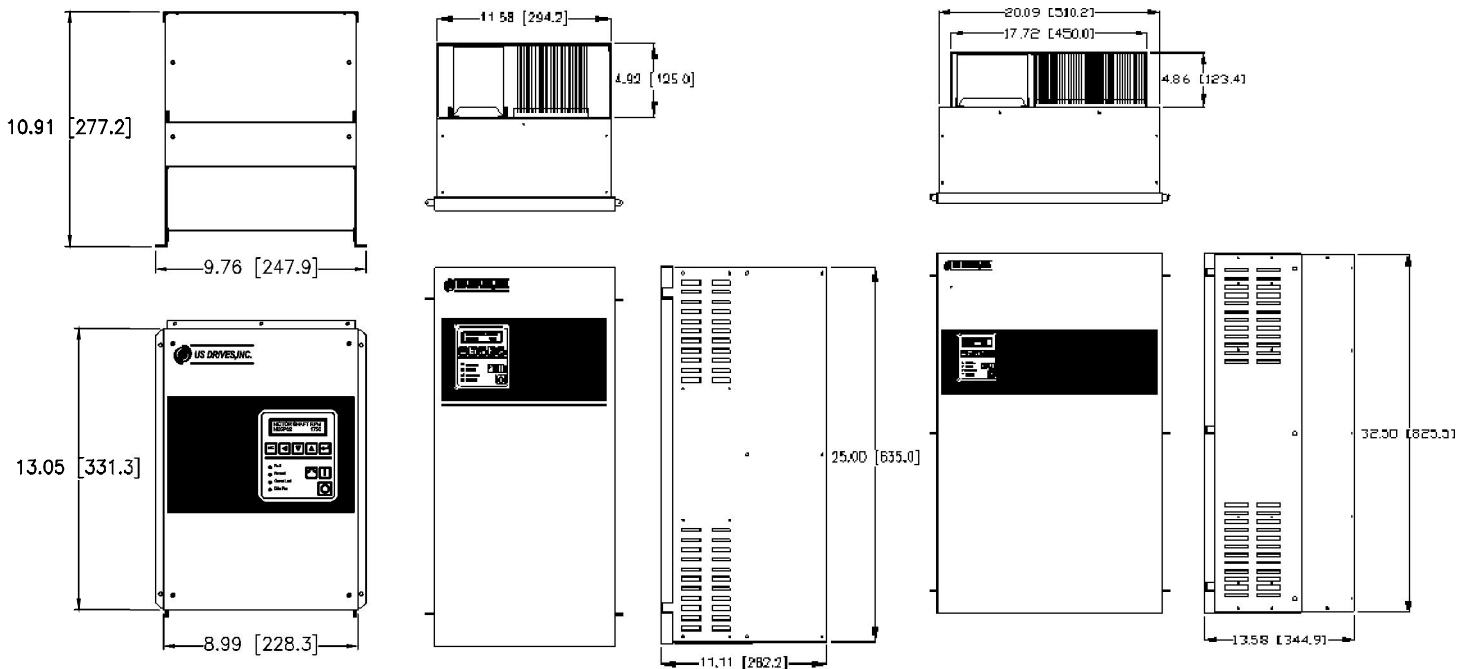

Figure 4

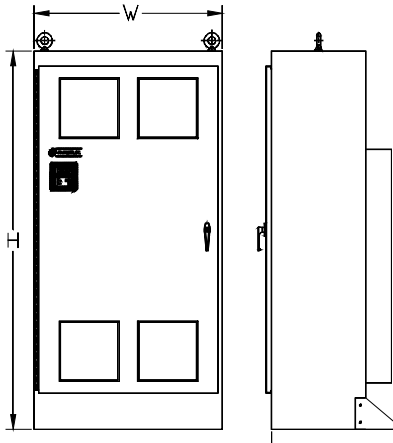

Figure 5

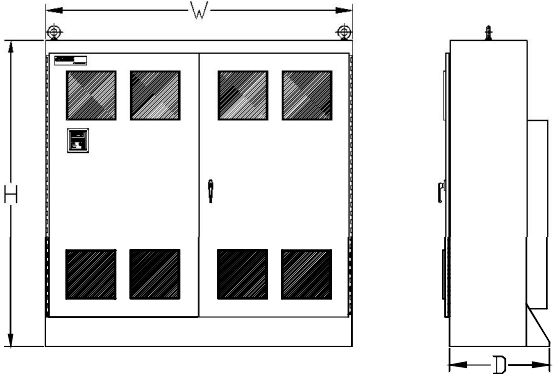

Figure 6

Dimensions - Nema 1 Enclosed VFD with Input Disconnect & Fuses

Input Voltage	Motor HP		Approximate Dimensions (HxWxD)	Figure	Mounting	Approximate Weight
	High Overload Capacity (HT)	Normal Overload Capacity (NT)				
200 - 250 VAC (208/230/240)	3 - 7.5	5 - 10	20.74" x 9.0" x 10.9"	7	Wall	46 Lbs.
	10 - 20	15 - 20	20.74" x 9.0" x 10.9"	7	Wall	46 Lbs.
	25 - 30	25 - 30	25" x 11.6" x 11.1"	8	Wall	85 Lbs.
	40 - 100	40 - 100	32.5" x 20.1" x 13.5"	9	Wall	190 Lbs.
	125 - 250	125 - 250	72" x 31.5" x 18"	11	Wall	700 Lbs.
	Above 250	Above 250	Consult Factory	-	-	-
380 - 500 VAC (380/400/415/480)	5 - 15	7.5 - 20	20.74" x 9.0" x 10.9"	7	Wall	46 Lbs.
	20 - 40	25 - 40	20.74" x 9.0" x 10.9"	7	Wall	46 Lbs.
	50 - 60	50 - 60	25" x 11.6" x 11.1"	8	Wall	85 Lbs.
	75 - 200	75 - 200	32.5" x 20.1" x 13.5"	9	Wall	190 Lbs.
	250 - 500	250 - 500	72" x 31.5" x 18"	11	Wall	700 Lbs.
	600 - 1000	600 - 1000	90" x 72" x 25.5"	12	Floor	1950 Lbs.
Above 1000	Above 1000	Consult Factory	-	-	-	
525 - 600 VAC (525/575/600)	5 - 15	7.5 - 20	20.74" x 9.0" x 10.9"	7	Wall	46 Lbs.
	20 - 40	25 - 40	20.74" x 9.0" x 10.9"	7	Wall	46 Lbs.
	50 - 75	50 - 75	25" x 11.6" x 11.1"	8	Wall	85 Lbs.
	100 - 200	100 - 200	32.5" x 20.1" x 13.5"	9	Wall	190 Lbs.
	250 - 600	250 - 600	72" x 31.1" x 18"	11	Wall	700 Lbs.
	700 - 1200	700 - 1200	90" x 72" x 25.5"	12	Floor	1950 Lbs.
Above 1200	Above 1200	Consult Factory	-	-	-	

Dimensions - Nema 12 Enclosed VFD with Input Disconnect & Fuses

Input Voltage	Motor HP		Approximate Dimensions (HxWxD)	Figure	Mounting	Approximate Weight
	High Overload Capacity (HT)	Normal Overload Capacity (NT)				
200 - 250 VAC (208/230/240)	3 - 7.5	5 - 10	20.74" x 9.0" x 10.9"	7	Wall	50 Lbs.
	10 - 20	15 - 20	20.74" x 9.0" x 10.9"	7	Wall	50 Lbs.
	25 - 30	25 - 30	25" x 11.6" x 11.1"	8	Wall	90 Lbs.
	40 - 100	40 - 100	32.5" x 20.1" x 13.5"	9	Wall	190 Lbs.
	125 - 250	125 - 250	72" x 36" x 23.5"	10	Floor	900 Lbs.
	Above 250	Above 250	Consult Factory	-	-	-
380 - 500 VAC (380/400/415/480)	5 - 15	7.5 - 20	20.74" x 9.0" x 10.9"	7	Wall	50 Lbs.
	20 - 40	25 - 40	20.74" x 9.0" x 10.9"	7	Wall	50 Lbs.
	50 - 60	50 - 60	25" x 11.6" x 11.1"	8	Wall	90 Lbs.
	75 - 200	75 - 200	32.5" x 20.1" x 13.5"	9	Wall	190 Lbs.
	250 - 500	250 - 500	72" x 36" x 23.5"	10	Floor	900 Lbs.
	600 - 1000	600 - 1000	90" x 72" x 25.5"	12	Floor	1950 Lbs.
Above 1000	Above 1000	Consult Factory	-	-	-	
525 - 600 VAC (525/575/600)	5 - 15	7.5 - 20	20.74" x 9.0" x 10.9"	7	Wall	50 Lbs.
	20 - 40	25 - 40	20.74" x 9.0" x 10.9"	7	Wall	50 Lbs.
	50 - 75	50 - 75	25" x 11.6" x 11.1"	8	Wall	90 Lbs.
	100 - 200	100 - 200	32.5" x 20.1" x 13.5"	9	Wall	190 Lbs.
	250 - 600	250 - 600	72" x 36" x 23.5"	10	Floor	900 Lbs.
	700 - 1200	700 - 1200	90" x 72" x 25.5"	12	Floor	1950 Lbs.
Above 1200	Above 1200	Consult Factory	-	-	-	

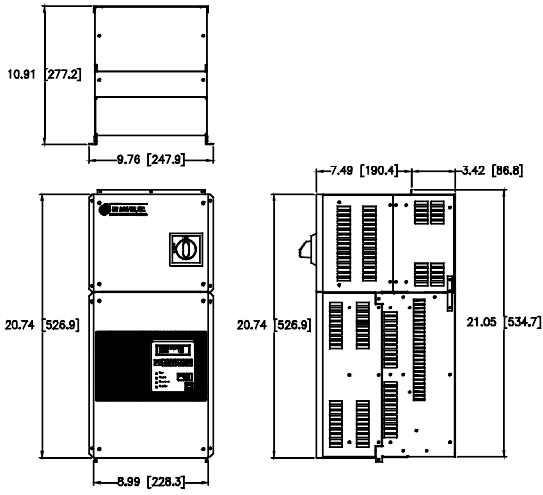

Figure 7

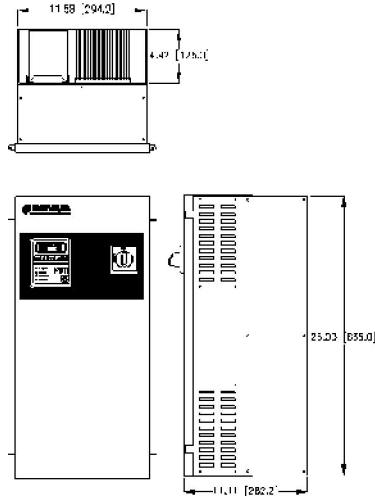

Figure 8

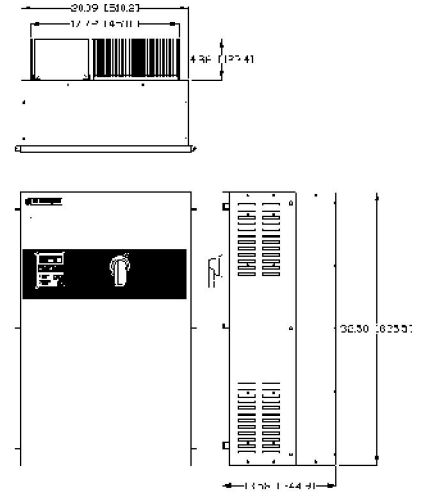

Figure 9

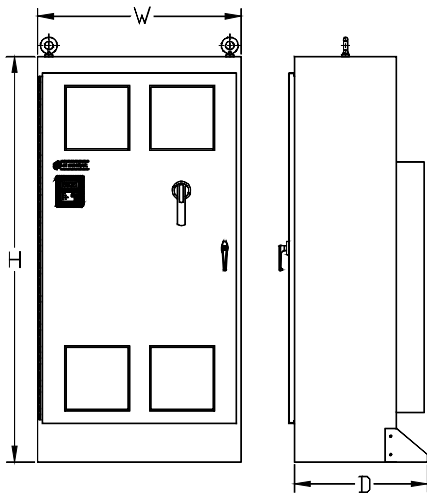

Figure 10

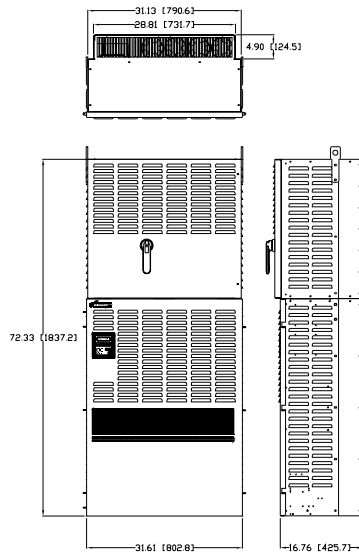

Figure 11

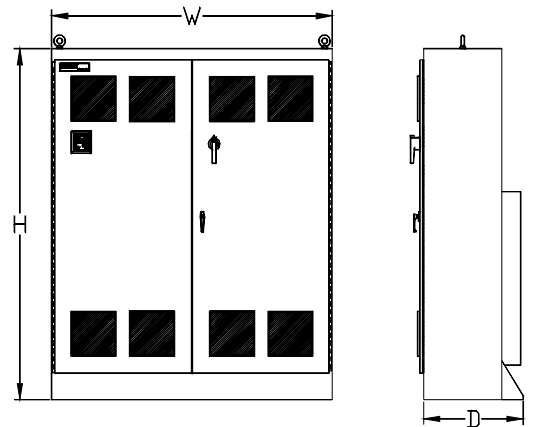

Figure 12

Dimensions - Nema 1 Enclosed VFD with Manual Contactor Bypass

Input Voltage	Motor HP		Approximate Dimensions (HxWxD)	Figure	Mounting	Approximate Weight
	High Overload Capacity (HT)	Normal Overload Capacity (NT)				
200 - 250 VAC (208/230/240)	3 - 7.5	5 - 10	34.02" x 9.0" x 10.9"	13	Wall	79 Lbs.
	10 - 20	15 - 20	34.02" x 9.0" x 10.9"	13	Wall	79 Lbs.
	25 - 30	25 - 30	38.4" x 11.6" x 11.1"	14	Wall	120 Lbs.
	40 - 100	40 - 100	65" x 20.1" x 13.5"	15	Wall	250 Lbs.
	125 - 200	125 - 200	72" x 72" x 23.5"	17	Floor	1400 Lbs.
	250	250	72" x 72" x 23.5"	17	Floor	1700 Lbs.
	Above 250	Above 250	Consult Factory	-	-	-
380 - 500 VAC (380/400/415/480)	5 - 15	7.5 - 20	34.02" x 9.0" x 10.9"	13	Wall	79 Lbs.
	20 - 40	25 - 40	34.02" x 9.0" x 10.9"	13	Wall	79 Lbs.
	50 - 60	50 - 60	38.4" x 11.6" x 11.1"	14	Wall	120 Lbs.
	75 - 200	75 - 200	65" x 20.1" x 13.5"	15	Wall	250 Lbs.
	250 - 400	250 - 400	72" x 72" x 23.5"	17	Floor	1400 Lbs.
	450 - 500	450 - 500	72" x 72" x 23.5"	17	Floor	1700 Lbs.
	600 - 1000	600 - 1000	Consult Factory	-	-	-
	Above 1000	Above 1000	Consult Factory	-	-	-
525 - 600 VAC (525/575/600)	5 - 15	7.5 - 20	24" x 24" x 14.2"	16	Wall	85 Lbs.
	20 - 40	25 - 40	24" x 30" x 14.2"	16	Wall	95 Lbs.
	50 - 75	50 - 75	38.4" x 11.6" x 11.1"	14	Wall	120 Lbs.
	100 - 200	100 - 200	65" x 20.1" x 13.5"	15	Wall	250 Lbs.
	250 - 400	250 - 400	72" x 72" x 23.5"	17	Floor	1400 Lbs.
	450 - 600	450 - 600	72" x 72" x 23.5"	17	Floor	1700 Lbs.
	700 - 1200	700 - 1200	Consult Factory	-	-	-
	Above 1200	Above 1200	Consult Factory	-	-	-

Dimensions - Nema 12 Enclosed VFD with Manual Contactor Bypass

Input Voltage	Motor HP		Approximate Dimensions (HxWxD)	Figure	Mounting	Approximate Weight
	High Overload Capacity (HT)	Normal Overload Capacity (NT)				
200 - 250 VAC (208/230/240)	3 - 7.5	5 - 10	34.02" x 9.0" x 10.9"	13	Wall	85 Lbs.
	10 - 20	15 - 20	34.02" x 9.0" x 10.9"	13	Wall	85 Lbs.
	25 - 30	25 - 30	38.4" x 11.6" x 11.1"	14	Wall	125 Lbs.
	40 - 100	40 - 100	65" x 20.1" x 13.5"	15	Wall	255 Lbs.
	125 - 200	125 - 200	72" x 72" x 23.5"	17	Floor	1450 Lbs.
	250	250	72" x 72" x 23.5"	17	Floor	1750 Lbs.
	Above 250	Above 250	Consult Factory	-	-	-
380 - 500 VAC (380/400/415/480)	5 - 15	7.5 - 20	34.02" x 9.0" x 10.9"	13	Wall	85 Lbs.
	20 - 40	25 - 40	34.02" x 9.0" x 10.9"	13	Wall	85 Lbs.
	50 - 60	50 - 60	38.4" x 11.6" x 11.1"	14	Wall	125 Lbs.
	75 - 200	75 - 200	65" x 20.1" x 13.5"	15	Wall	255 Lbs.
	250 - 400	250 - 400	72" x 72" x 23.5"	17	Floor	1450 Lbs.
	450 - 500	450 - 500	72" x 72" x 23.5"	17	Floor	1750 Lbs.
	600 - 1000	600 - 1000	Consult Factory	-	-	-
	Above 1000	Above 1000	Consult Factory	-	-	-
525 - 600 VAC (525/575/600)	5 - 15	7.5 - 20	24" x 24" x 14.2"	16	Wall	85 Lbs.
	20 - 40	25 - 40	24" x 30" x 14.2"	16	Wall	95 Lbs.
	50 - 75	50 - 75	38.4" x 11.6" x 11.1"	14	Wall	125 Lbs.
	100 - 200	100 - 200	65" x 20.1" x 13.5"	15	Wall	255 Lbs.
	250 - 400	250 - 400	72" x 72" x 23.5"	17	Floor	1450 Lbs.
	450 - 600	450 - 600	72" x 72" x 23.5"	17	Floor	1750 Lbs.
	700 - 1200	700 - 1200	Consult Factory	-	-	-
	Above 1200	Above 1200	Consult Factory	-	-	-

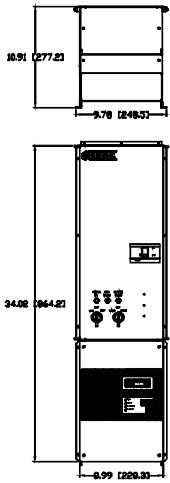

Figure 13

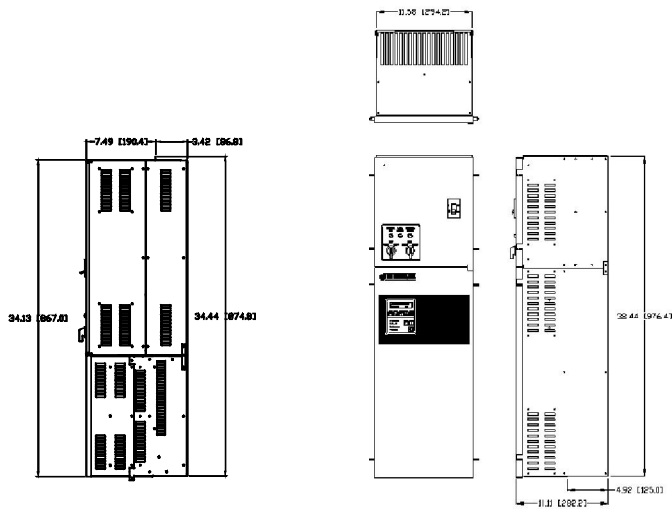

Figure 14

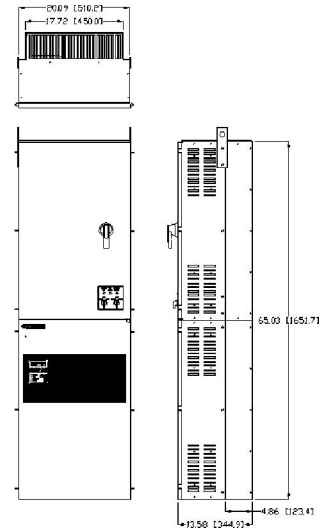

Figure 15

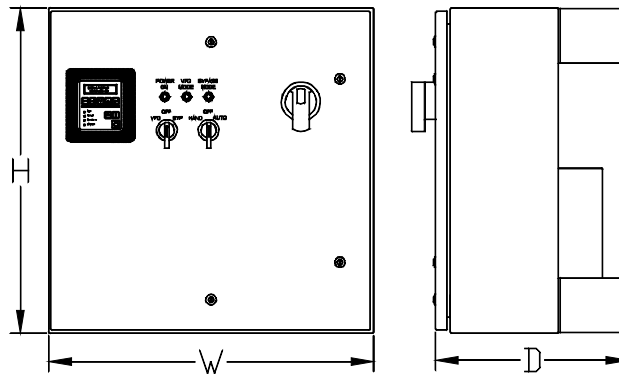

Figure 16

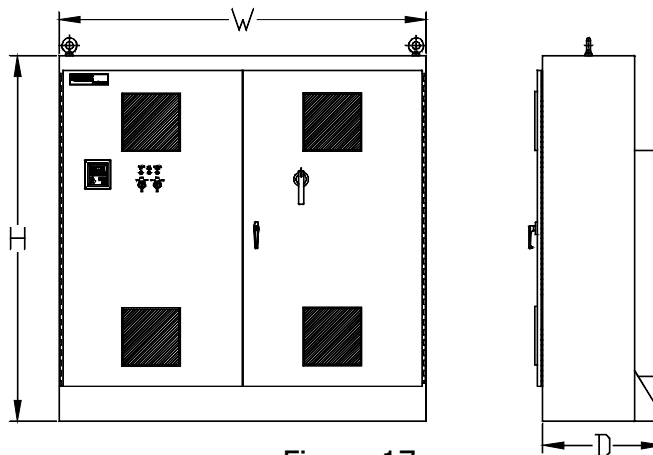

Figure 17